

POTENTIAL OF BURIED PIPES SYSTEMS AND DERIVED TECHNIQUES FOR PASSIVE COOLING OF BUILDINGS IN BRAZILIAN CLIMATES

Pierre Hollmuller¹, Joyce Carlo², Martin Ordenes², Fernando Westphal², Roberto Lamberts²

¹Centre universitaire d'étude des problèmes de l'énergie (CUEPE),
Université de Genève – Switzerland

²Laboratório de Eficiência Energética em Edificações (LabEEE),
Universidade Federal de Santa Catarina – Brazil

ABSTRACT

Objective of this study is to evaluate the cooling potential of buried pipes and a derivative thereof, for buildings situated in Brazilian climate. In a first step, the cooling potential of these techniques is characterized independently of any building dynamic, in terms of the available temperature differential relatively to a specified comfort set point, with simulation performed by way of a specific model. In a second step, the effective response of a residential as well as of a commercial building is evaluated by way of Energyplus, in free-floating as well as in air-conditioning mode.

KEYWORDS

passive cooling, buried pipes, inertial ventilation

INTRODUCTION

In Brazil as well as in Europe, air conditioning has been a straightforward response to excess heat in buildings. This rapidly growing induces important electricity consumption but also sharpens the load profile at peak hours, becoming an issue as well for electricity companies as for building owners.

As an alternative response to air conditioning, proper conception of building envelope may help to keep the building within the comfort zone (in free-floating mode) or to reduce expected cooling load (in air-conditioning mode). Further reduction or suppression of air conditioning may be achieved by using passive or low-energy cooling techniques. Two of such techniques will be investigated here. Both use inertia for active storage of the meteorological day/night temperature oscillation carried by ventilation, and may be classified as inertial ventilation techniques.

Buried pipes are used by forcing ambient air through the soil, underneath or next to the building, so as to dampen the daily oscillation and to avoid temperature peaks during daytime. Derived thereof, thermal phase-shifting is realized by driving the air flow through a type of rock-bed storage of very precise dimension, enabling to delay the temperature peak over time almost without dampening.

Objective of this study is to evaluate the potential of these inertial ventilation techniques for cooling of buildings in Brazilian climates. In a first step, this cooling potential will be characterized independently of any building dynamic, in terms of the available temperature differential relatively to a specified comfort set point. In a second step, the effective response of a residential as well as of a commercial building will be evaluated for a free-floating building, in terms of achievable comfort conditions (percentage of temperature overshoots within building), as well as in backup mode of an air-conditioning system, in terms of achievable electricity savings.

Complements to this article, concerning for example the layout and control of the inertial ventilation systems, are to be found in the complete report, available online [Hollmuller et al. 2006b].

CLIMATES

This study will focus on six of the major Brazilian cities, on basis of standard meteorological data in hourly time step [Goulart et al. 1997]. They may globally be characterized and differentiated in terms of their average temperature, as well as their yearly and daily temperature amplitudes (Tab. 1). In terms of cooling problematic, they may further be characterized by the frequency of temperature overshoots during day / night periods (6 – 18 h / 18 – 6 h), as evaluated over the whole year or merely over the hottest two months (Fig. 1).

Table 1: Climatic zones

City	Mean ¹⁾	Year ²⁾	Day ²⁾
	C	K	K
Brasilia	20.7	3.2	9.5
SãoPaulo	18.8	5.4	7.0
Rio de Janeiro	23.6	6.0	5.0
Recife	25.7	2.6	3.0
Florianopolis	20.7	7.7	5.7
Porto Alegre	19.2	10.6	8.0

1) Mean annual temperature

2) Yearly and daily amplitude, as given by Fourier analysis of hourly data over one year.

Year (365 days)

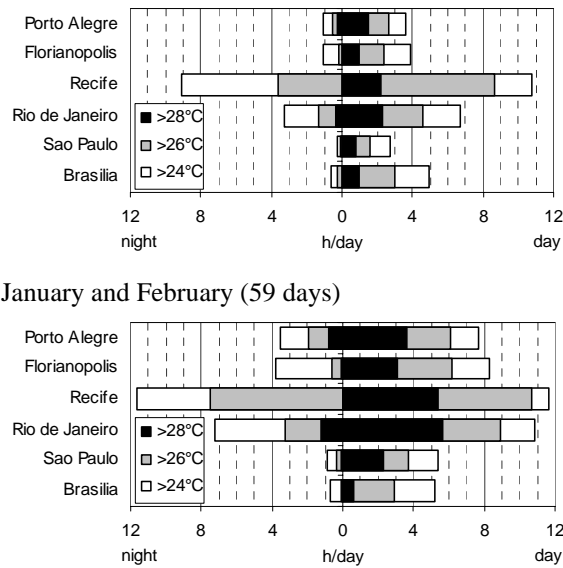

Figure 1: Ambient temperature overshoots during day / night periods (6 – 18 h / 18 – 6 h).

We hence keep in mind the following classification:

- Situated on the coast, Recife and Rio de Janeiro are the hottest of these cities, with small seasonal as well as daily amplitudes. Most hours of the year exceed 24°C, during day as well as during night, and over the hottest months half of the diurnal hours exceed 28°C.
- Situated off the coast and somewhat in altitude, Brasilia and São Paulo have milder average temperatures and more important daily amplitudes, but still relatively small seasonal variations. As a consequence, temperature overshoots are only diurnal, and much less frequent than for the preceding cities.
- Situated south of the tropic of Capricorn, on the coast, Florianopolis and Porto Alegre have more important seasonal variations than Brasilia and São Paulo, for similar average temperatures and daily amplitudes. Temperature overshoots hence remain similar when evaluated over the whole year, but get more important when evaluated over the hottest two months.

INERTIAL VENTILATION

Buried pipes

An air/soil heat exchanger consists of a set of buried pipes situated at the entrance of the ventilation system, underneath or next to the building. Depending on the chosen geometry and dimension, it is used for dampening of the daily or the yearly meteorological oscillation, so as to avoid corresponding hot or cold temperature peaks. Although derivatives of it have been applied over centuries in more or less traditional forms, a modern

revival of the technique has been manifest in Europe over the last decade, with construction and critical analysis of pilot and demonstration installations as well as production of simulation tools and thumb rules for engineers [Hollmuller 2002; Hollmuller et al. 2005].

It was in particular shown that yearly dampening of the meteorological oscillation requires quite huge systems, with about 2-3 m soil around each pipe. We will hence focus on configurations for dampening of the daily meteorological oscillation, which can be achieved with barely 15-20 cm earth around the pipes, enabling for compact and cost-efficient systems, possibly in multi-layer. With such a compact array, complete dampening is achieved with about 1 m² tube exchange surface for each 5-15 m³/h of airflow, depending on pipe diameter and air velocity (1-4 m/s). In mid-European climates, with summers characterized by diurnal overshoots but average daily temperatures usually within the 20-26°C comfort zone, such a system yields comfortable ventilation temperatures on a 24/24 h basis, which enables to evacuate heat loads from the building (if necessary with airflows enhanced up to several air change per hour, and correspondingly dimensioned pipes).

In agreement with preceding rules, the configuration selected for this study consists of a multi-layer array of pipes of 20 cm diameter and 30 m length, with 50 cm inter-axial distance, each treating a 200 m³/h airflow.

Thermal phase-shifter

Discovered by way of an analytical study on previously described buried pipes [Hollmuller 2003], thermal phase-shifting relates to previously described air/soil heat exchangers, but aims in delaying rather than dampening of the daily temperature oscillation carried by the airflow, so as to have the temperature peak of the night available in the middle of the day. A specific theoretical and experimental study allowed to understand the basic physical phenomenon, as well as to develop lab prototypes for complete 12 h phase-shifting of the daily meteorological oscillation [Hollmuller et al 2006a].

The idea consists in forcing the airflow through a packed bed, which consists of thin and homogenous heat storage particles or layers. Making use of an enhanced exchange surface and of a small heat penetration depth, thermal phase-shifting basically resumes in using the thermal inertia of the packed bed so as to slow down the temperature wavelength which is naturally carried by the air velocity.

On the experimental level, the development of lab prototypes, with different filling materials (ceramic balls or slabs, so as gravel), confirms the possibility of complete 12 h phase-shifting of the daily

meteorological oscillation, with an order of magnitude of 1 m^3 storage material per $100 \text{ m}^3/\text{h}$ airflow. The associated amplitude transmission may be as high as 80%, but varies strongly from one configuration to the other, in particular because of non homogenous airflows, in relation with non homogenous particle geometries or piling up.

Throughout this study we will focus on one of the developed lab prototypes, which consists of piled up 1.7 cm thick ceramic slabs with a 2 mm air gap between them. For a $200 \text{ m}^3/\text{h}$ airflow as before, complete 12 h phase shifting of the daily temperature oscillation can be reached with 60% amplitude transmission, for a system of 50 x 50 cm cross-section and 6 m length (5 time less than with buried pipes).

Simulation tool

Simulation of the above defined inertial ventilation systems occurs by way of an analytical solution for a constant airflow with harmonic input temperature, taking into account convective heat exchange between air and pipe or slab, as well as heat diffusion within the soil, with adiabatic border conditions [Hollmuller 2003]. Computation of the system output occurs by applying latter solution to Fourier analyzed hourly meteorological data over one year, a method which was extensively validated against a finite difference numerical simulation model [Hollmuller and Lachal 2005].

Buried pipes

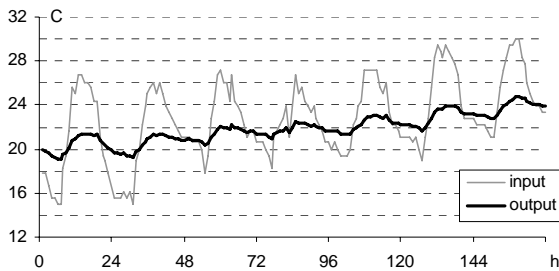

Thermal phase-shifter

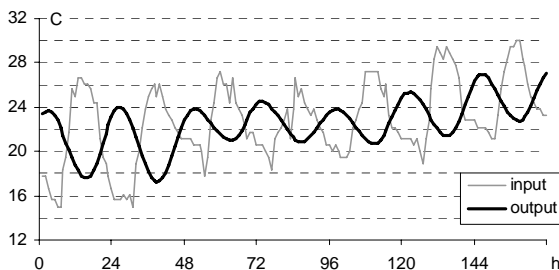
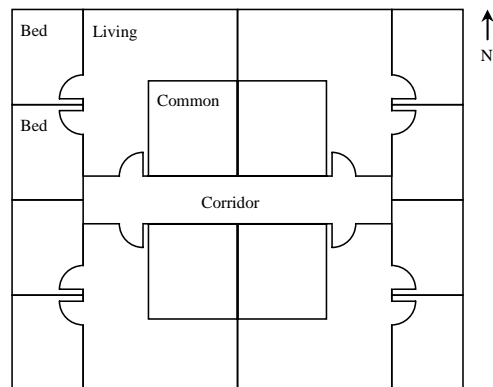

Figure 2: Inertial ventilation systems, simulation on a typical summer week (Florianopolis, week 52).

BUILDINGS

Although the cooling potential of latter strategies may be defined independently of any building, their effective usefulness depends on the cooling needs, which are determined by the building envelope, the internal loads, as well as the period of occupancy during which a specific comfort has to be reached. For this purpose we will consider both a residential building (with afternoon/night occupancy) and a commercial building (with day occupancy only).

Residential building



Commercial building

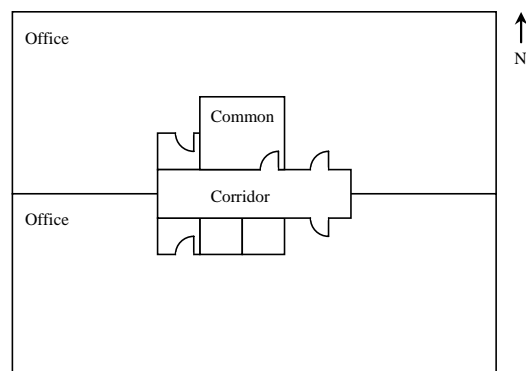

Figure 3: Architectural layout.

Architectural layout

The residential building under consideration is a typical low-cost residential building as massively constructed all over the country, representing 15% of the constructed multi-dwelling buildings for middle class revenue [Tavares, 2006]. It consists of 4 floors, each of 2.8 m height, on a ground area of 16 x 19 m. Each floor is divided into 4 flats, each consisting of one living room, two bedrooms, a kitchen and a bathroom. This layout is described by way of a simplified thermal model of 5 zones per floor: two for the living rooms, facing respectively north and south ($2 \times 40 = 80 \text{ m}^2$), two for the bedrooms, facing

respectively east and west ($2 \times 48 = 96 \text{ m}^2$) and one for the commons and the corridor (128 m^2).

Very similar in shape, the commercial building also consists of 4 floors, each of 3.0 m height, on a ground area of $15 \times 20 \text{ m}$. Each floor is divided into two open-plan offices (130 m^2 each), facing north and south, and of a central area for corridor and commons (40 m^2), which define the thermal zone model in a straightforward manner.

Thermal and constructive characteristics

Thermal and constructive characteristics are similar for both buildings (Tab. 2):

- External walls are made of concrete blocks and mortar (residential) or clay blocks and mortar (commercial), without other thermal insulation.
- As a preliminary thermal measure, although unusual for such buildings, the roof includes a thermal insulation (residential: 5 cm; commercial: 2.5 cm) with an air gap.
- Windows are made of simple 3 mm clear glazing, with a reasonable window to wall ratio.
- Unlike for typical constructions of this type, but as an additional constructive cooling measure, fixed shading devices on the facades are designed to cut off excessive solar gains. However, for the sake of comparison, a configuration without shading will also be considered.
- Infiltration rate is 1.5 ach, in free-floating as well as in air-conditioning mode. This constant value is maintained along with inertial or direct ventilation. For the sake of comparison, a configuration with tighter envelope (0.5 ach) will also be considered.

Table 2: Thermal characteristics and internal loads of residential and commercial building

	Resid.	Comm.
External walls		
thermal capacity (KJ/K.m^2)	280	270
overall U-value ¹⁾ (W/K.m^2)	4.5	5.2
Windows		
window/wall (%)	17.9	16.3
window/floor ²⁾ (%)	16.7	12.4
Roof		
overall U-value ¹⁾ (W/K.m^2)	0.7	1.8
Internal loads		
comfort zones ³⁾ ($\text{Wh/m}^2.\text{day}$)	176	150
other ⁴⁾ ($\text{Wh/m}^2.\text{day}$)	71	60

1) Convective exchange not included.

2) Commons not included.

3) Residential: living rooms and bed rooms ($176 \text{ m}^2/\text{floor}$); Commercial: offices ($260 \text{ m}^2/\text{floor}$).

4) Residential: commons and corridor ($128 \text{ m}^2/\text{floor}$); Commercial: commons and corridor ($40 \text{ m}^2/\text{floor}$).

Occupancy, internal loads and hvac

Occupancy in the residential building is schematically divided in a first period in the living rooms (14 – 22h, 30 W/m^2 internal loads), and a second period in the bedrooms (22 – 7h, 15 W/m^2).

Although air-conditioning is not yet affordable for population of such buildings, its possible generalization might give raise to important energy consumption. Alternatively to the free-floating mode, we hence also consider cooling and heating with individual fan coils in living and bedrooms, limited to the respective occupancy periods. Upper and lower setpoints will be 18 and 24°C , as usual in Brazil when such hvac systems are available.

Occupancy in the commercial building is supposed to extend over daytime only (8 – 18h, 15 W/m^2).

Air-conditioning in the offices will only be active during occupancy, with same standard 18°C and 24°C setpoints as before. However, for the sake of comparison, all configurations will also be tested in free-floating mode.

Controlled ventilation

As an alternative or as a backup to air conditioning, we will evaluate cooling of the occupancy zones by way of controlled ventilation, at a rate of 5 ach, with air driven directly from ambient and/or through the inertial ventilation systems previously defined.

So as to account for the total airflow of the residential building ($9900 \text{ m}^3/\text{h}$), some 50 pipes need to be buried on a double layer underneath the building, corresponding to a 375 m^3 excavation/storage volume, 12.5 m wide by 1 m deep. Similarly, in the case of the commercial building ($15600 \text{ m}^3/\text{h}$), some 80 pipes need to be installed, corresponding to a 600 m^3 excavation/storage volume. As noted before, the phase-shifter option requires 5 times smaller storage volumes, for which the detailed hydraulic layout however remains to be designed.

As both inertial ventilation techniques are based on thermal storage of the meteorological day/night temperature oscillation, they require a constant 24/24h driven airflow through the storage medium. Enhanced ventilation of the building for cooling purposes however only makes sense when the temperature at storage output is effectively lower than in the building (as is also the case for direct ventilation from ambient, usually only activated at night). As is obvious from Fig. 2, it is hence beneficial to use inertial ventilation with a thermal controller and an exhaust valve at storage output, for the warm air to be driven back to ambient during critical periods: in particular so for thermal phase-shifting, with temperature peaks not dampened out but only delayed in time.

So as to take further advantage of the fresh ambient at night, which is lower than at storage output, use of an alternate ventilation strategy may also be considered, using whichever of the two sources presents a lower temperature (ambient or inertial storage). Since ventilation through the inertial storage has to be maintained 24/24h, such a strategy however requires a specific fan and bypass for direct ventilation from ambient.

Tested configurations

Finally, the thermal response of the above defined buildings will be evaluated for following architectural configurations and ventilation strategies:

- A reference case (Base) consisting of the above defined buildings, with shading devices and basic 1.5 ach infiltration, but without active ventilation.
- Two building alternatives, one without shading (NoShade), the other with a tighter 0.5 ach envelope (Tight), both without active ventilation.
- Controlled direct ventilation from ambient (Dir), for the base case building.
- Controlled inertial ventilation with buried pipes, in simple mode (Pipe) as well as in alternate mode (PipeDir), for the base case building.
- Controlled inertial ventilation with phase-shifter, in simple mode (Shift) as well as in alternate mode (ShiftDir), for the base case building.

Simulation tool and methodology

Simulation of the above defined configurations are carried out with Energy Plus (version 1.2.1.022), with following specific procedures and hypothesis:

- As is common for simulation of multi-floor buildings, latter are defined by way of three typical floors (hence with a total of 15 thermal zones for the residential building, 9 zones for the commercial building): a bottom floor, with ground coupling as given by the software algorithm; a top floor, including coupling to ambient by way of above defined roof; finally a unique intermediate floor, with coupling to precedent floors.
- As version 1.2.1.022 of Energy Plus did not yet allow for ventilation of a thermal zone by way of data read from a file, a specific procedure for introduction of the temperatures from the separately simulated inertial ventilation systems was developed. The procedure consists in defining a virtual thermal zone, with an hourly defined temperature as given by inertial ventilation, and to define controlled ventilation from that zone to the actual thermal zones of interest.

- As well for São Paulo as for Florianopolis, constant 24/24 h inertial ventilation is activated from September to May, with injection into the building controlled separately for each thermal zone (except for commons, which are not ventilated). In real situation, such an individualized control might be limited by technical or economic questions, but allows here for determination of the optimized cooling potential.
- In air-conditioning mode, inertial ventilation is considered as a backup technology. Control of inertial ventilation occurs in the same way as in free-floating mode, independently of the hvac system being on or off.
- Electricity consumption of the inertial ventilation system bases on estimated charge losses in the thermal storage of 10 Pa (buried pipes), respectively 50 Pa (phase-shifter), as measured on different such systems. The main consumption however goes for air distribution in the building, which was estimated to be possible with 100 Pa. Latter value is also being retained for controlled direct ventilation, although latter strategy could also be used in a decentralized way.
- Electricity consumption of the hvac system bases on a COP of 3 for cooling and a fan consumption of 0.3 W per m³/h air, corresponding to individual fan coils.

COOLING POTENTIAL

In a first step, the cooling potential of the ventilation strategies may be characterized independently of any building dynamic, in relation to a specified comfort set point of 24, 26 or 28°C: as long as the airflow is cooler than the set point it may be driven into the building, and the cooling potential is defined by the difference between these two temperatures; in the other case the airflow must not enter the building, and the cooling potential is zero.

The various strategies may be characterized in terms of the daily average of this cooling potential during day / night periods (6 – 18 h / 18 – 6 h), as evaluated over the whole year or merely over the hottest two months. Results for the six climatic zones are as follows:

- The effect of inertial ventilation is obvious: by dampening or differing of the oscillation peak, inertial ventilation enables for better distribution or shifting of the cooling potential towards the diurnal periods, yielding an advantage for buildings which could not store the cooling potential of the night within their proper thermal mass.
- Obviously, the combination of inertial ventilation and direct ventilation (PipeDir and ShiftDir)

always shows a higher potential than inertial ventilation in stand alone mode (Pipe and Shift).

- However, because of their hot climate, Rio de Janeiro and Recife may not count with inertial ventilation for cooling below 26°C. Even with a set point at 28°C, cooling potential remains extremely low: during hottest months less than 30 K.h/day over day time (corresponding to less than 10 kWh/day per 1000 m³/h air).
- When averaged over the whole year, all other cities bear more reasonable but still limited values: for a set point at 28°C, depending on the ventilation strategy, 90 – 120 K.h/day over day time (30 – 40 kWh/day per 1000 m³/h air) and approximately twice as much over 24h. Furthermore, because of somewhat milder average temperatures, the yearly average cooling potential still exists for a set point at 24°C.
- The situation is different when evaluated over the hottest months only (January and February). Whereas the cooling potential persists almost unchanged for São Paulo and Brasilia, with 70 – 90 K.h/day, latter is not the case any more for Florianopolis and Porto Alegre, with 40 – 60 K.h/day, because of higher summer temperatures due to a stronger seasonal dynamic.

EFFECTIVE COOLING

We will now explore the effective building response to the different ventilation strategies, in terms either of temperature overshoots in free-floating mode, or of electricity savings in air-conditioning mode.

Because of the poor cooling potential in the hot climatic zones (Rio, Recife) and the need to limit the number of simulations, this analysis will only concern the cities of São Paulo and Florianopolis (Fig. 4).

The annually integrated simulation values yield following results for the warm but not excessively hot climate of São Paulo.

- In free-floating mode, a building with reasonable internal loads and correct solar protections may benefit from inertial ventilation, as well for afternoon/night occupancy (residential) as for a daytime occupancy (commercial). In the first case, inertial ventilation strategies allow to suppress more than half of the hours above 26°C, and just as much of the hours above 24°C. The effect is a little less important for day occupancy, although overshoots above 28°C are now completely suppressed.
- Globally, similar results are obtained with controlled direct ventilation from ambient, however with somewhat more overshoots in the

26-28°C range, as well as residual overshoots above 28°C in the case of diurnal occupancy.

- Electricity for ventilation however remains a key issue, with values close to that of an optimized hvac system, at least for residential buildings. Values presented here could be reduced by a factor 2/3, by activation of the ventilation system over the 6 warmest instead of 9 warmer months, but limitation of the charge losses in the distribution system remains a key factor.
- For the same reason, inertial ventilation used as a back-up of air-conditioning is of little or no advantage, at least for a set point as low as 24°C. As a matter of fact, important savings in electricity consumption for the hvac system are compensated by additional electricity for ventilation, in particular for its distribution in the building. This conclusion concerns an optimized hvac-system, with a COP of 3, and should again be balanced by the fact that the activation period of inertial ventilation could be reduced to the hottest 6 months only. As seen before, peak loads during the hottest days of the year will however remain unchanged.
- In any case, proper conception of the building envelope, in particular regarding solar protection, remains a preliminary measure to cooling techniques based on controlled ventilation.

Similarly, the annually integrated values for Florianopolis are as follows:

- Again, proper conception of the building envelope, in particular regarding solar protection, remains a preliminary measure to any cooling technique based on controlled ventilation.
- In free-floating mode, because of a hotter summer, both free-floating buildings eventually rise above 28°C, even with the use of inertial ventilation (except for the case of phase-shifting used in combination with direct ventilation). Even so, inertial ventilation globally lowers the occurrence of the diverse overshoot levels. In the case of mixed day/night occupancy (residential building), the result however remains close to that of controlled direct ventilation, so that the clear advantage of inertial ventilation, in particular thermal phase-shifting, appears only for buildings with day-occupancy.
- Electricity for ventilation still remains a key issue, but is globally 2 to 3 times less than for an optimized hvac-system. Again, these values could be further reduced by activation of the ventilation system over the 6 warmest months only.
- Inertial ventilation used as a back-up of air-conditioning here clearly is of no advantage,

neither in terms of peak loads nor of totalized

electricity consumption.

Residential building (6205 h occupancy)

Commercial building (3650 h occupancy)

São Paulo, free-floating mode

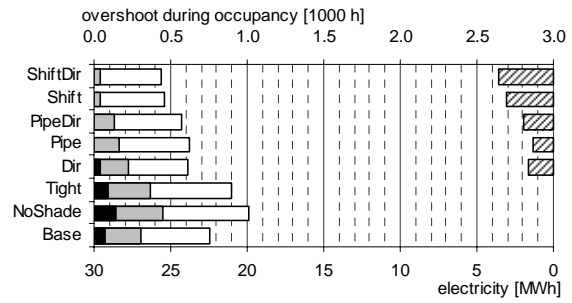
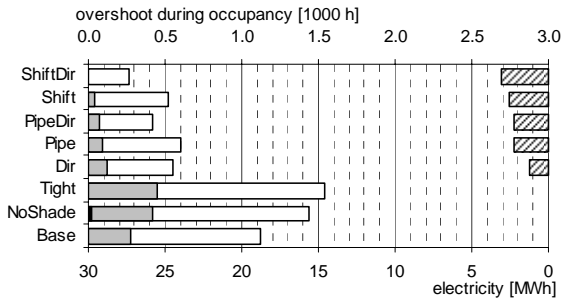

São Paulo, air-conditioning mode

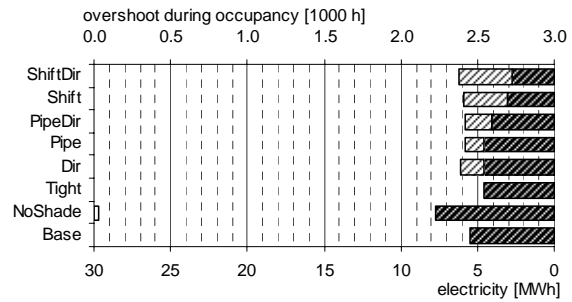
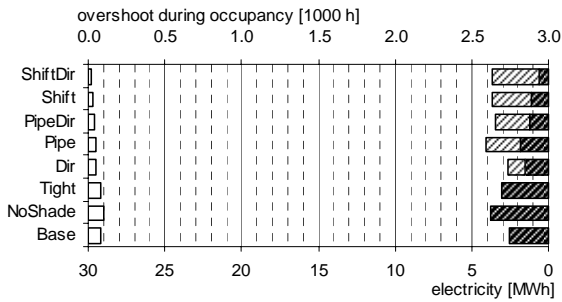

Florianopolis, free-floating mode

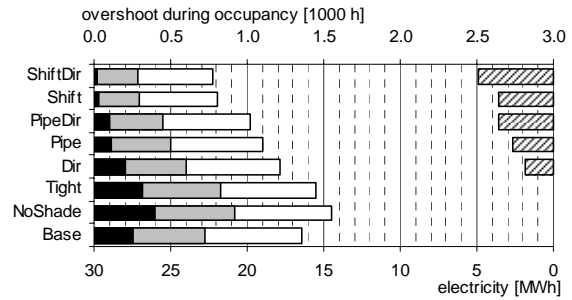
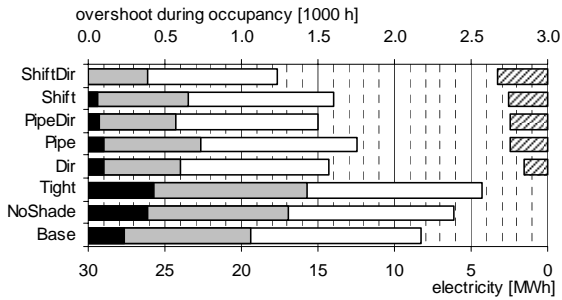

Florianopolis, air-conditioning mode

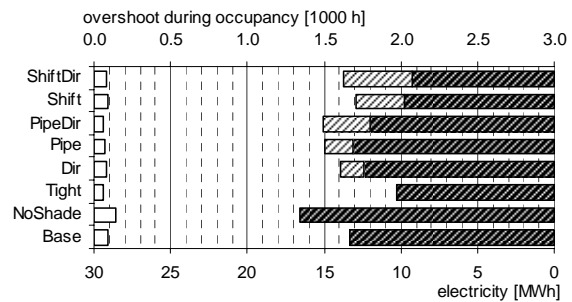
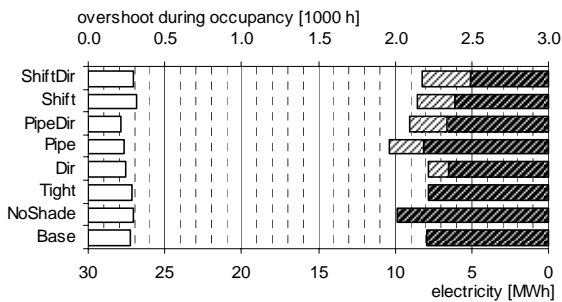

temperature overshoot

□ > 24°C □ > 26°C ■ > 28°C

electricity

▨ air-conditioning □ ventilation

Figure 4: Annual temperature overshoot and electricity consumption.

CONCLUSIONS

Objective of this study was to evaluate the potential of two inertial ventilation techniques for passive cooling of buildings in Brazilian climates.

In a first step, the cooling potential of these techniques was characterized independently of any building dynamic, in terms of the available temperature differential relatively to a specified comfort set point. For hot climates like Rio de Janeiro and Recife one may not count with inertial ventilation for cooling below 26°C. Even with a set point at 28°C, cooling potential remains extremely low : during hottest months less than 30 K.h/day over day time (corresponding to less than 10 kWh/day per 1000 m³/h air). The better potential in the case of São Paulo and Brasilia (70 – 90 K.h/day) is somewhat reduced for Florianópolis and Porto Alegre (40 – 60 K.h/day), because of higher summer temperatures due to a stronger seasonal dynamic.

In a second step, the effective response of a residential as well as of a commercial building was evaluated in free-floating as well as in air-conditioning mode, with climatic data of São Paulo and Florianópolis. The simulation results show that proper conception of the building envelope, in particular regarding solar protection, is a preliminary measure to cooling techniques based on controlled ventilation.

In a climate with important day/night oscillation, a free-floating building with reasonable internal loads and correct solar protections may benefit from inertial ventilation, with a reduction of the extreme building temperatures by 1 to 3 K, depending on the ventilation strategy. Since these techniques are based on storage of the day/night temperature oscillation. The usefulness of these techniques further depends on the occupancy schedule : in the case of a residential building, a comfort level similar to that of inertial ventilation can hence be obtained with direct ventilation from ambient. The clear advantage of inertial ventilation, in particular of thermal phase-shifting, hence only appears for buildings with day-occupancy. Electricity for ventilation however remains a key issue, which should be analyzed in more detail : in the case of São Paulo, the estimated electricity consumption is close to that of an optimized hvac system.

In a general way, at least with a set point as low as 24°C, use of inertial ventilation as a backup to air-conditioning does not bring about any benefit, neither in terms of peak load reduction, nor of annual energy savings.

ACKNOWLEDGMENT

The authors wish to thank the Swiss Commission for Research Partnership with Developing Countries (KFPE) for financial support of this study.

REFERENCES

- Goulart S., Lamberts R., Firmino S. (1997) Dados climáticos para projeto e avaliação energética de edificações para 14 cidades brasileiras. Florianópolis: UFSC, 345 p. (www.labeee.ufsc.br/downloads/downloadaclim.html).
- Hollmuller P. (2002) Utilisation des échangeurs air/sol pour le chauffage et le rafraîchissement des bâtiments: mesures in situ, modélisation analytique, simulation numérique et analyse systémique (Thèse). Université de Genève, Faculté des Sciences.
- Hollmuller P. (2003) Analytical characterisation of amplitude-dampening and phase-shifting in air/soil heat-exchangers. *International Journal of Heat and Mass Transfer*, vol. 46, p. 4303-4317.
- Hollmuller P., Lachal B., Pahud D. (2005) *Rafrâchissement par géocooling: bases pour un manuel de dimensionnement*. Genève, CUEPE, Université de Genève.
- Hollmuller P., Lachal B. (2005) Buried pipe systems with sensible and latent heat exchanges: validation of numerical simulation against analytical solution and long-term monitoring, in: *Building Simulation, proceedings of the 9th International Building Performance Simulation Association*, 15-18 August 2005, École Polytechnique de Montréal, Vol.1, p. 411-418.
- Hollmuller P., Lachal B., Zraggen J.M. (2006) A new ventilation and thermal storage technique for passive cooling of buildings: thermal phase-shifting, in: *PLEA 2006 - The 23rd Conference on Passive and Low Energy Architecture*, 6-8 September 2006, Geneva, Switzerland, Université de Genève, Vol. 1, p. 541-546.
- Hollmuller P., Carlo J., Ordenes M., Westphal F., Lamberts R. (2006) Potential of buried pipes systems and derived techniques for passive cooling of buildings in Brazilian climates, Ed. by CUEPE, Université de Genève.
- www.unige.ch/cuepe/html/biblio/detail.php?id=412
- Tavares, S. F. (2006), *Metodologia para análise energética do ciclo de vida de blocos cerâmicos vermelhos*. Tese (Doutorado em Engenharia Civil), Programa de Pós-graduação em Engenharia Civil, Universidade Federal de Santa Catarina, Florianópolis, 2006.